

A modern, multi-level building with a minimalist design. The building features large concrete blocks, dark vertical slats, and a prominent glass entrance. A rooftop garden with various plants is visible on one of the upper levels. The sky is clear and blue.

# GPA GLOBAL DISPLAY CATALOG 2024

gpa GLOBAL

BEYOND PACKAGING UNBOXING POTENTIAL

## Display & POS Material



Located in Mexico City, GPA Foli has 664 employees and is one of the leading companies in high-end packaging sectors; such as spirits, beverages, candies, chocolates, toys, and more.

This facility specializes in custom display and POS Materials and has a team of 15 designers to help bring your vision to life, all produced within North America for reduced costs and quick turn around times.



# Display & POS Material



DIGITAL- Cutting-Edge Technology

In the past 5 years we have strengthened our POS & Display capabilities with the acquisition of the most advanced technology in the world to manufacture displays and POS materials.



CONCEPTUAL &  
STRUCTURAL  
DESIGN



PRODUCTION



ASSEMBLY



FULLFILMENT

BEYOND PACKAGING UNBOXING POTENTIAL

## Display & POS Material

Throughout our experience, we have found standard needs at the point of purchase, such as size, quick assembly and load structure.

The objective of this catalog is to offer display options that are viable, creative and produced in record time.



# Index Displays

**Floorstand  
Interchangeable  
cover**

**Floorstand  
Quick Assembly**

**Floorstand  
Double-Sided**

**Floorstand  
Metallic Reinforced**

**Floorstand  
Lego-like**

**Floorstand  
Reinforced**

**Sidekick**

**Small  
Sidekick**

**Long  
Sidekick**

**Endcap  
One-Piece  
PDQ Tray**

**Counter Display  
One-Piece  
PDQ Tray**

**Tiered  
Pallet Display**

**Double Sided View**

**Pallet Display  
with Dump Bin**

**Pallet Display**

**False Pallet**

**Maxi-Tray**

**Banner Display with  
Base**

**Standee**

# Floorstand Interchangeable cover

SD\_001

- Manufactured in corrugated cardboard
- Semi-automatic assembly
- Interchangeable cover to display different artworks reusing the same display frame Ideal for multi-brand exhibitions
- Unfold it to assemble and place cover on top

Assemble in  
**2**  
Minutes



Video

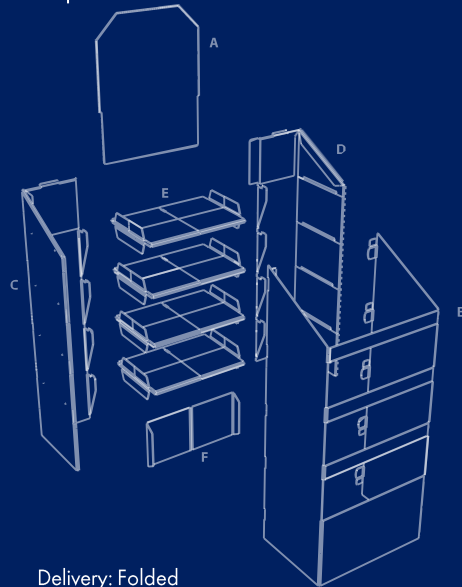

Delivery: Folded  
in box; on pallet

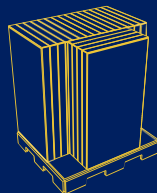

Perfect size to fit in a small car

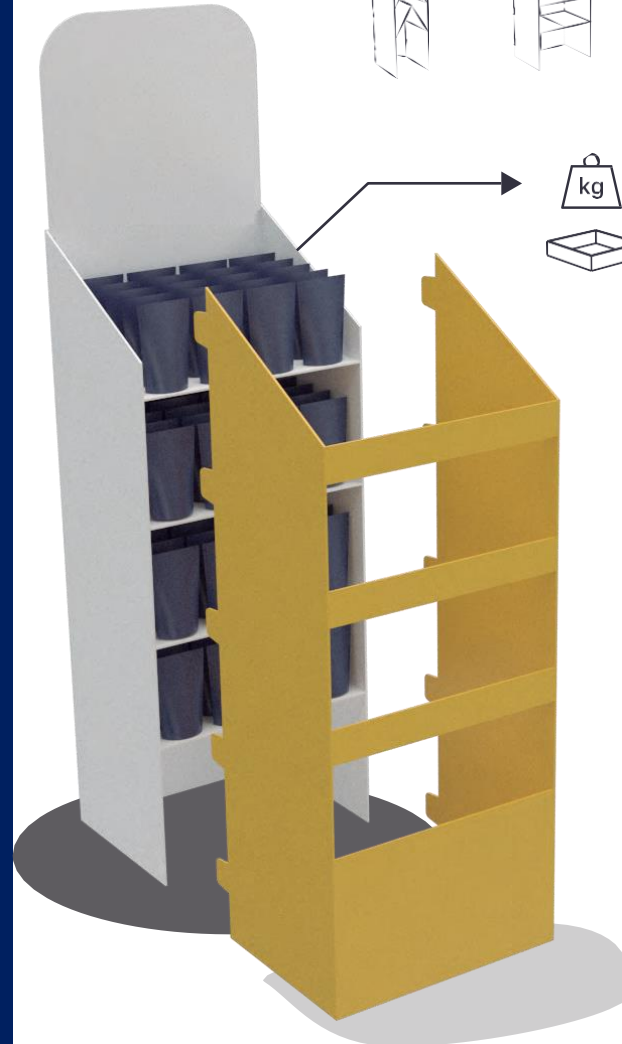
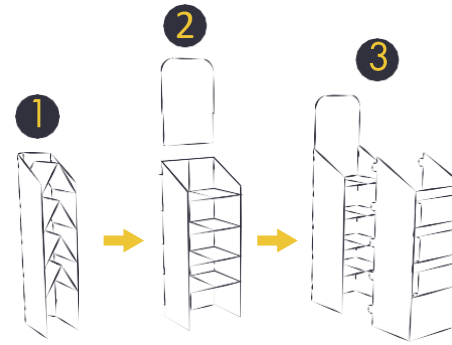

Load per level 4 kg

Space for product  
34 cm x 43 cm

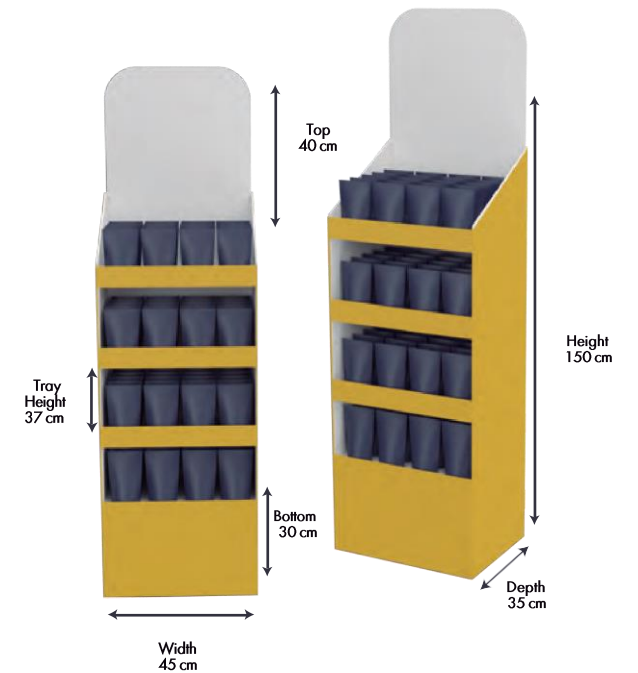

# Floorstand Quick Assembly

SD\_002

- Manufactured in corrugated cardboard
- Designed for extremely quick setup at retail
- Easy to transport
- Optimizes supply chain, eliminates hand assembly
- Unfold it to assemble; secure tray and place at retail

Assemble in  
**1**  
Minute



Video

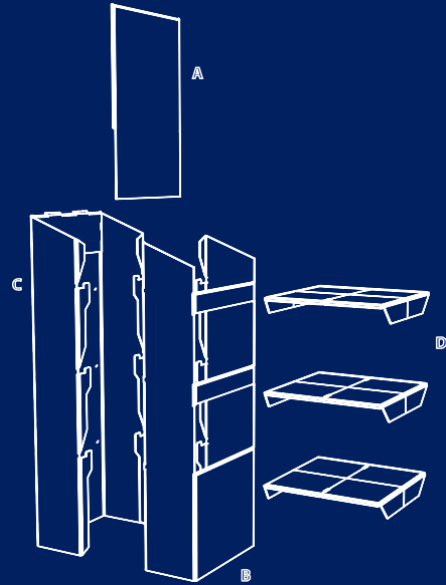

Delivery: Folded  
in box; on pallet

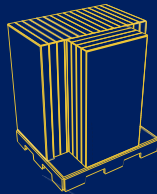

Perfect size to fit in a small car

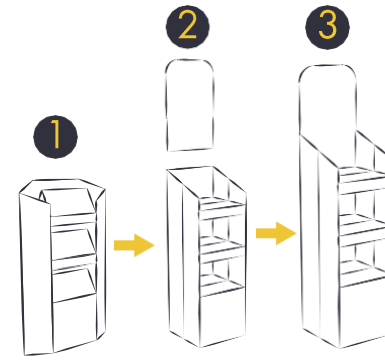
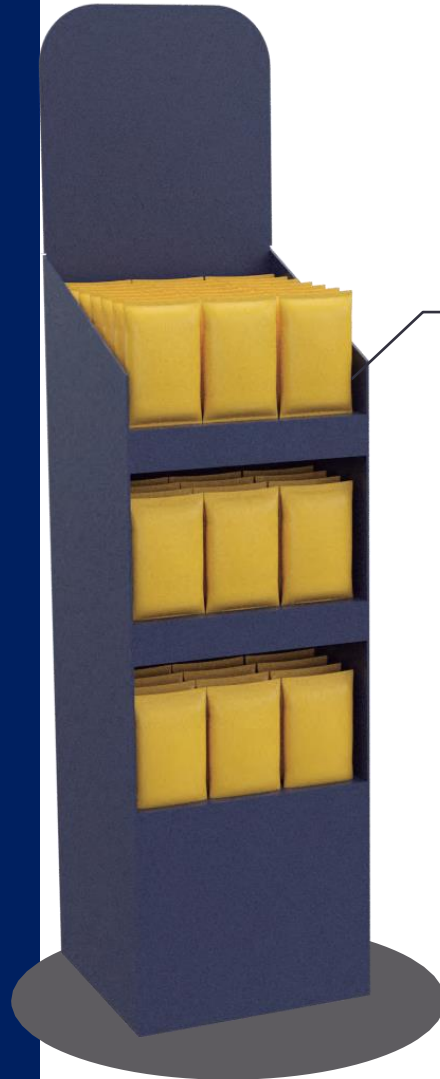

Load per level 6 Kg.

Space for product  
39 x 37 cm

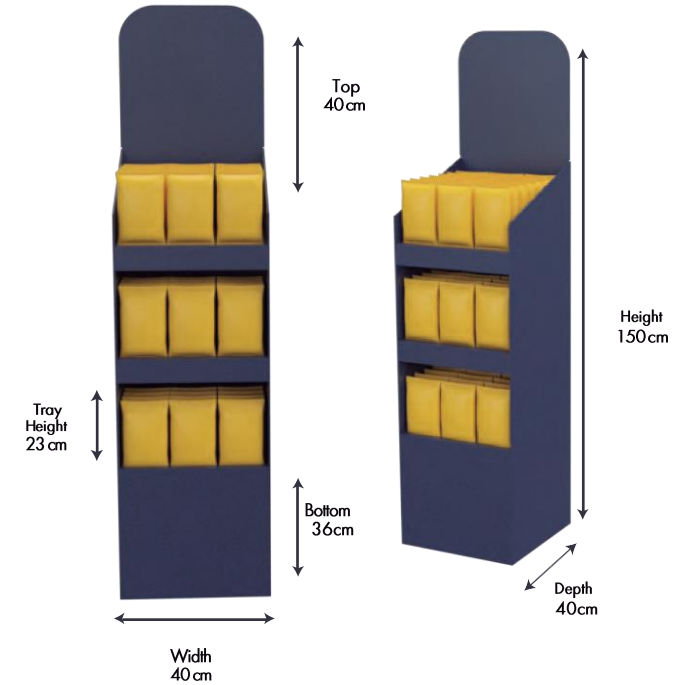

# Floorstand Double-Sided

SD\_003

- Manufactured in corrugated cardboard
- Prebuilt Cardboard trays
- Double-sided allows more space for branding
- Easy to transport
- Unfold it to assemble; secure tray, top and place at retail



Video

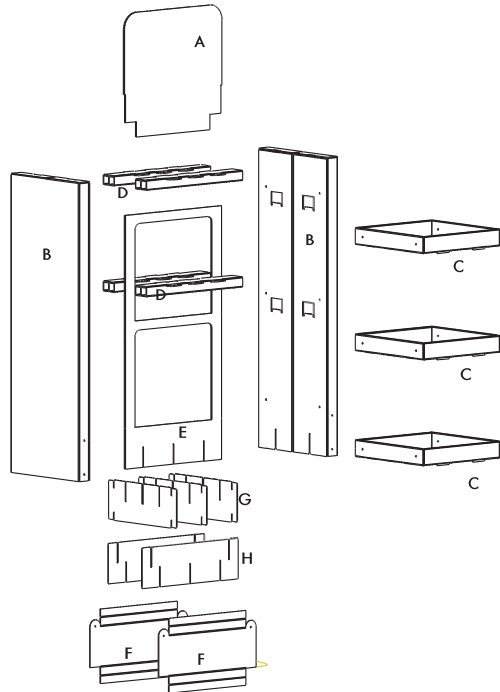

Perfect size to fit in a small car

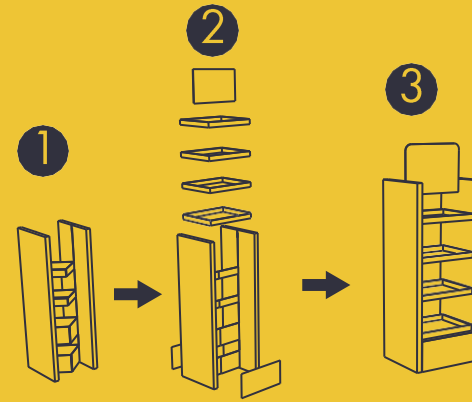

kg Load per level 6 Kg.  
Space for product 39 x 37 cm



Tray  
Height  
24 cm

Top  
30 cm

Bottom  
15 cm

Width  
43 cm

Height  
140 cm

Depth  
38 cm



# Floorstand Metallic Reinforced

SD\_009

- Manufactured in corrugated cardboard
- Designed for quick setup at retail
- Metallic reinforced design to support heavier products
- Unfold it to assemble; place metal reinforcements and assemble trays to place at retail

Assemble in  
**1**  
Minute



Video

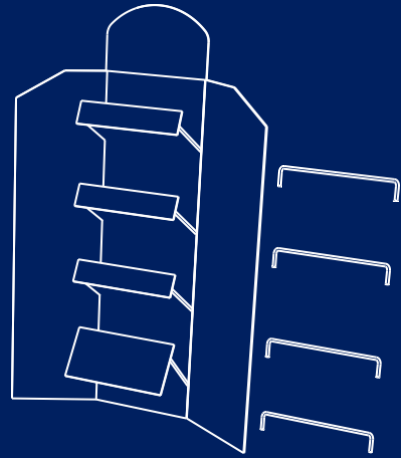

Delivery:  
Folded in box;  
on pallet

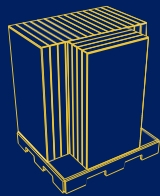

Perfect size to fit in a small car

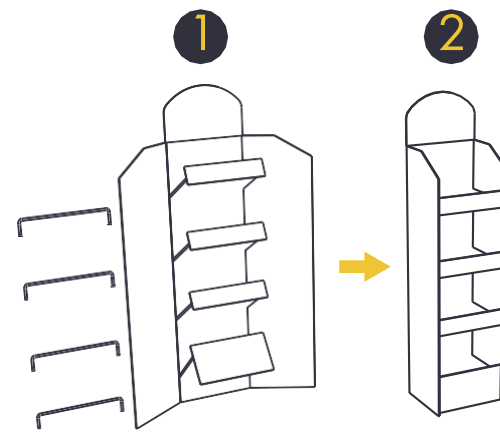

Load per level 15 Kg.

Space for product  
34x27 cm

Metal reinforcement

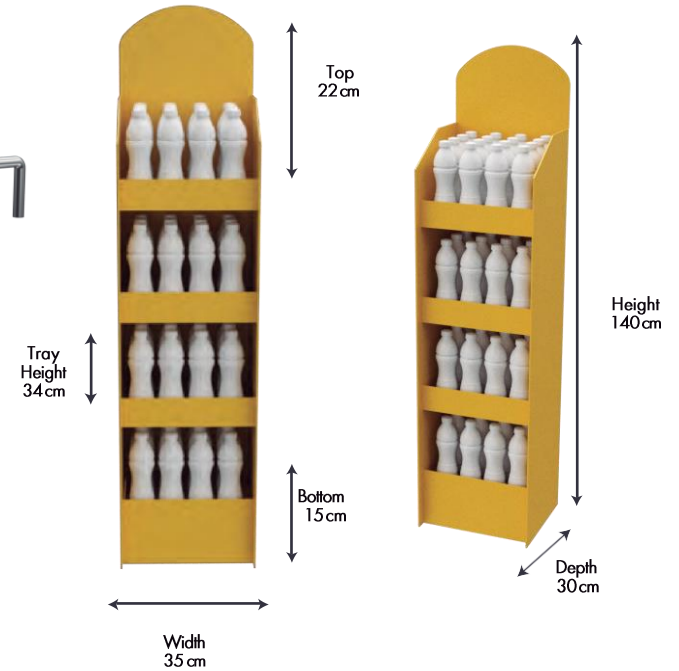

# Floorstand Lego-like

SD\_005

- Manufactured in corrugated cardboard
- Semi-automatic assembly enable quick and easy setup at retail
- Modular stacking components
- Delivered in a cardboard briefcase
- Unfold it to assemble and stack components to place at retail

Assemble in  
**2**  
Minutes



Video

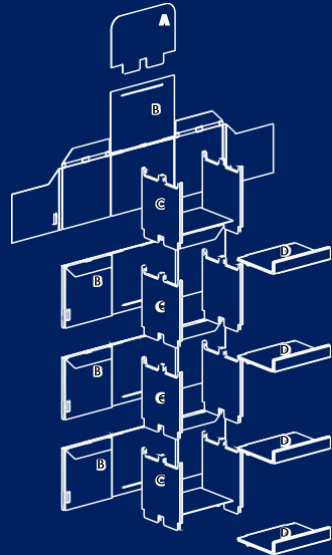

Delivery:  
Folded in box;  
on pallet



Perfect size to fit in a small car

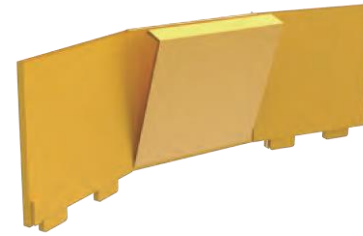

Load per level 15 Kg.

Space for product  
31 x 29 cm

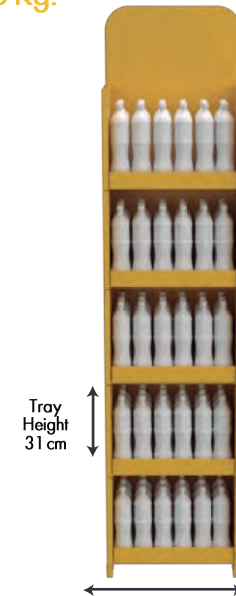

Width  
35 cm

Top  
20 cm



Height  
170 cm

Depth  
31 cm

# Floorstand Reinforced

SD\_010

- Manufactured in corrugated cardboard
- Double-sided allows for more branding space
- Designed for quick setup at retail
- Unfold it to assemble; secure tray, top and place at retail



Video

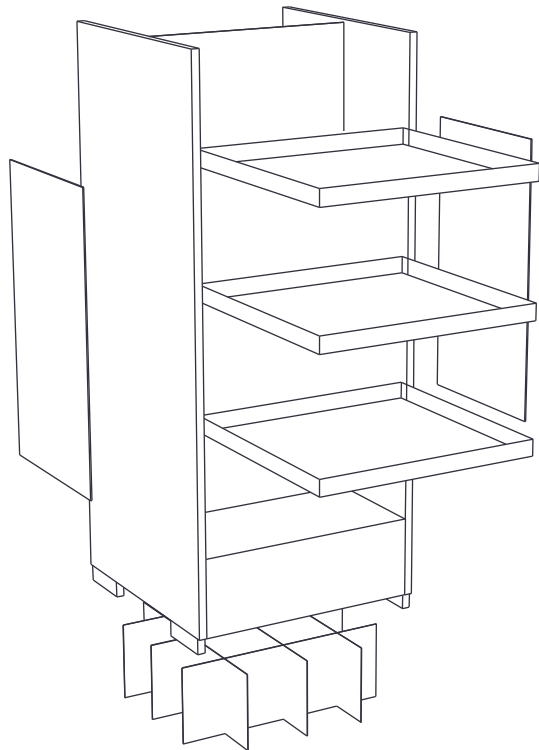

Delivery:  
Folded in box;  
on pallet

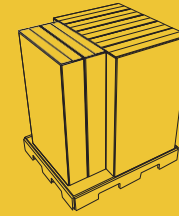

kg Load per level 25 Kg.  
Space for product  
55x55 cm

Tray  
Height  
26 cm

Bottom  
19 cm

Height  
140 cm

Depth  
60 cm

Width  
60 cm

# Sidekick

SD\_004

- Manufactured in corrugated cardboard
- Easy to hang system from shelf sides
- Designed for quick setup at retail
- Options for hanging and tray products
- Unfold to assemble, secure trays and place at retail



Video

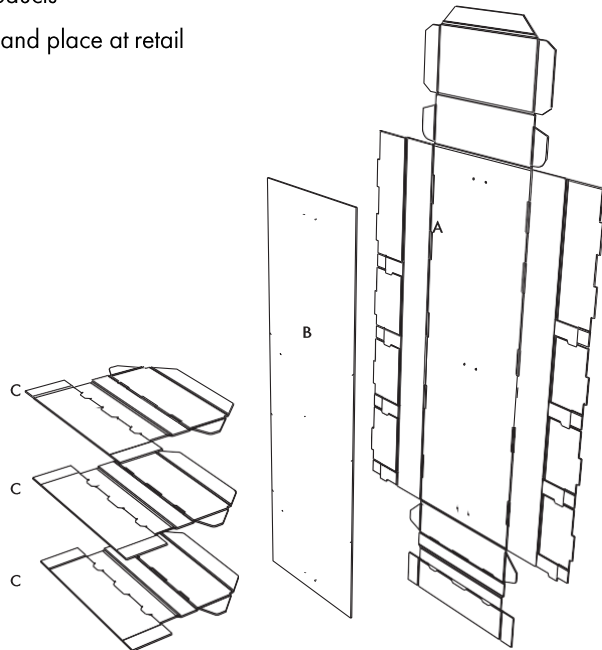

Delivery:  
Folded in box;  
on pallet

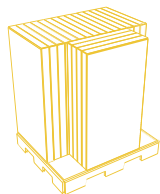

Perfect size to fit in a small car



Load per level 1.5 Kg.



Space for product  
38 x 10 cm

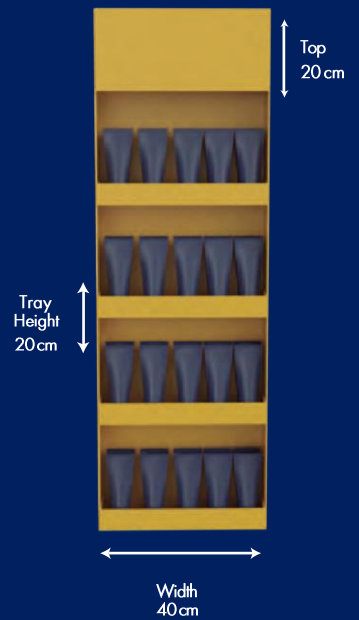

# Small Sidekick

- Manufactured in corrugated cardboard
- Designed for quick setup at retail
- Large branding area
- Unfold it to assemble at retail



Video

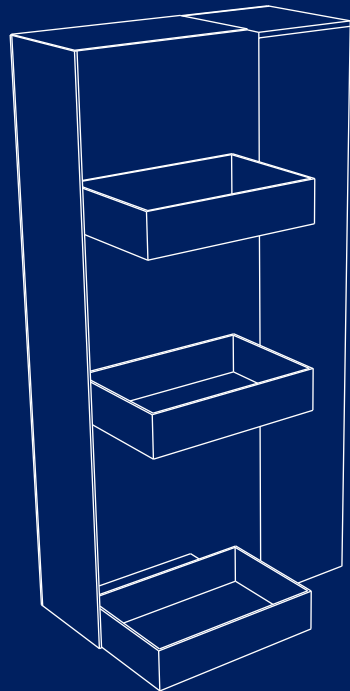

Perfect size to fit in a small car



Load per level 1 Kg.

Space for product  
14 x 19 cm



Width  
35 cm



Height  
68 cm

Depth  
13 cm

# Long Sidekick

SD\_016

- Manufactured in corrugated cardboard
- Designed for quick setup at retail
- Ideal for multi-brand exhibition and temporalities
- Unfold to assemble, secure trays and place at retail



Video

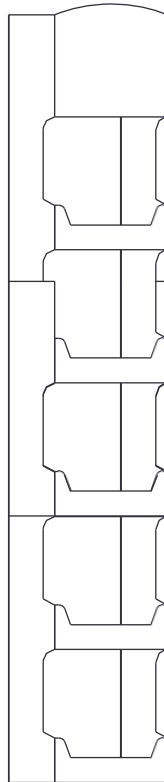

 Load per level .5 Kg.  
 Space for product  
8x5 cm

  
Perfect size to fit in a small car

 Width  
9 cm

 Top  
Banner  
18 cm

 Height  
91 cm  
 Depth  
6 cm

# Endcap One-Piece PDQ Tray

SD\_012

- Manufactured in corrugated cardboard
- Designed for quick setup at retail
- Large space for branding
- Unfold it to assemble and place at retail

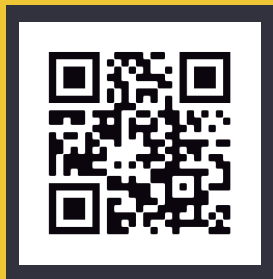

Video



Perfect size to fit in a small car

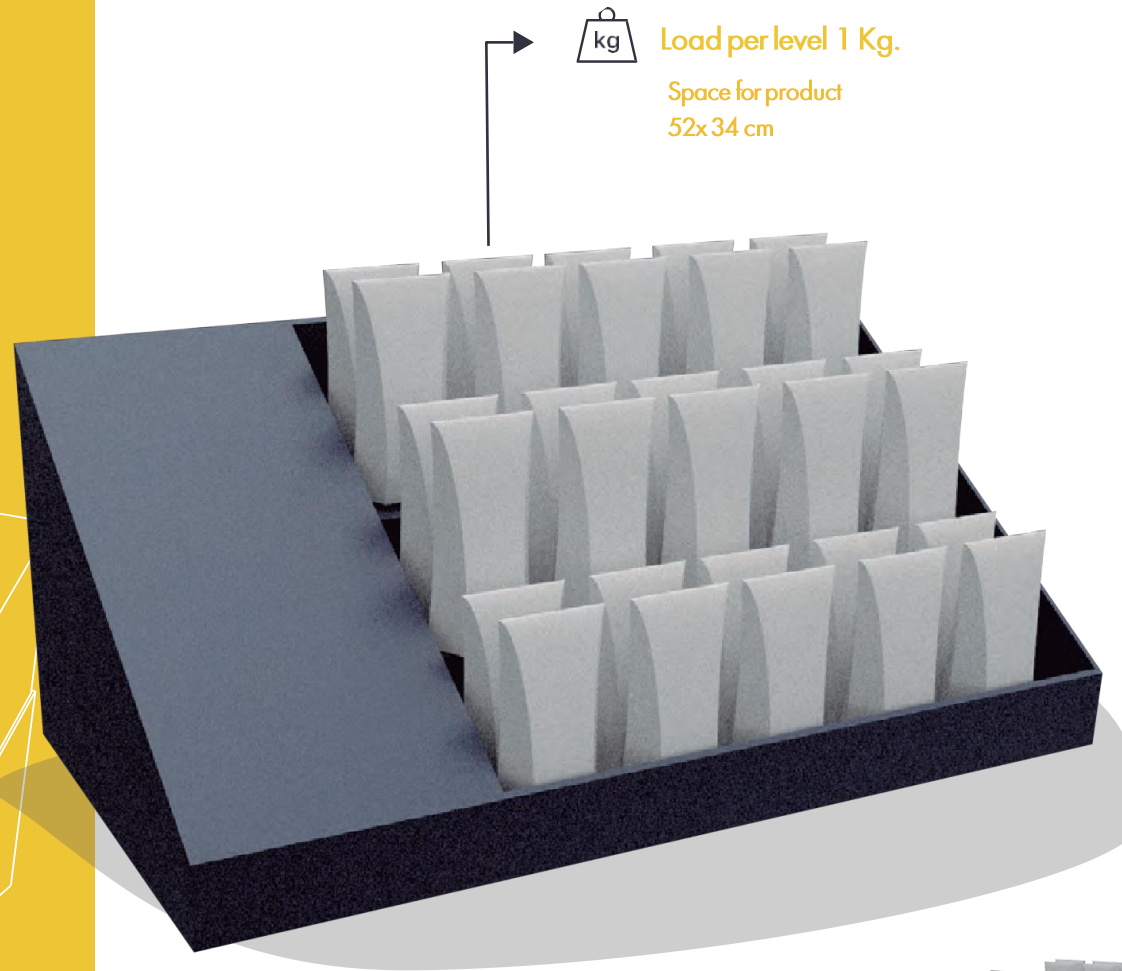

Load per level 1 Kg.

Space for product  
52x34 cm

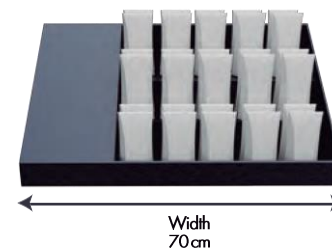

Width  
70cm



Height  
30cm

Depth  
35cm

# Counter One-Piece PDQ Tray

SD\_020

- Manufactured in corrugated cardboard
- Designed for quick setup at retail
- Ideal for counter product visibility
- Large space for branding
- Unfold it to assemble and place at retail



Video

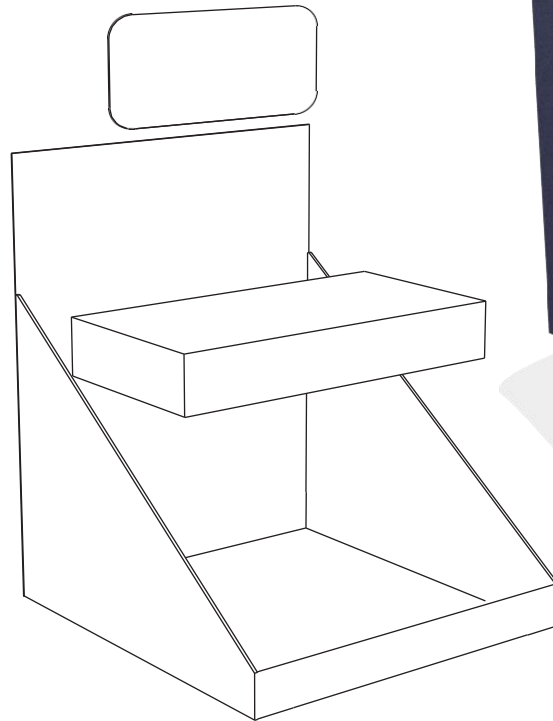

Load per level 4 Kg.



Space for product  
37 x 27 cm



Perfect size to fit in a small car



Width  
38 cm

Top  
Banner  
14 cm



Depth  
28 cm

Height  
30 cm



# Tiered Pallet Display

SD\_006

- Manufactured in corrugated cardboard
- Reinforced design supports heavier products
- Unfold it to assemble and place at retail



Delivery:  
Folded in box; on  
pallet

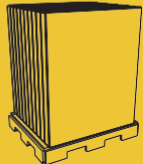

Load per pallet 100 Kg.

Space for product  
119x23 cm

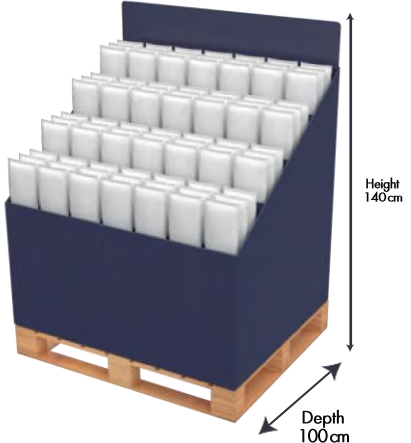
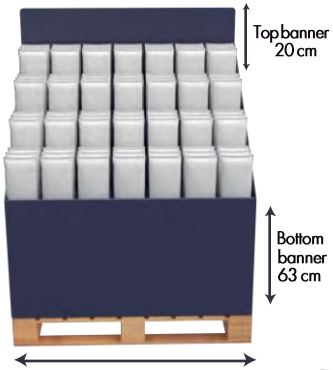

# Double sided View

SD\_008

- Manufactured in corrugated cardboard

Delivery:  
Folded in box; on pallet

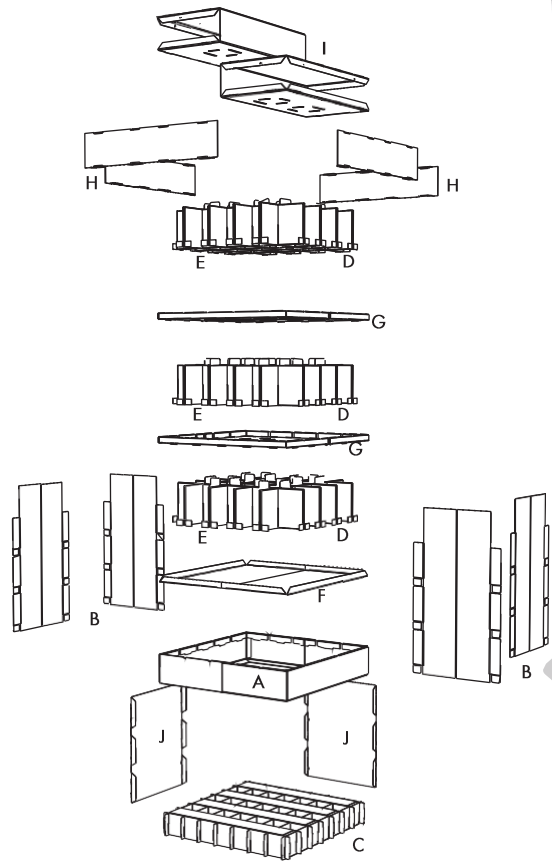
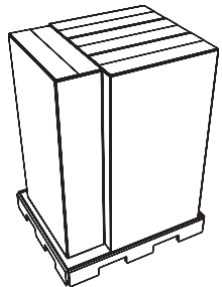

kg Load per 110 Kg.

Space for product  
94x22 cm

Space for product  
74x22 cm

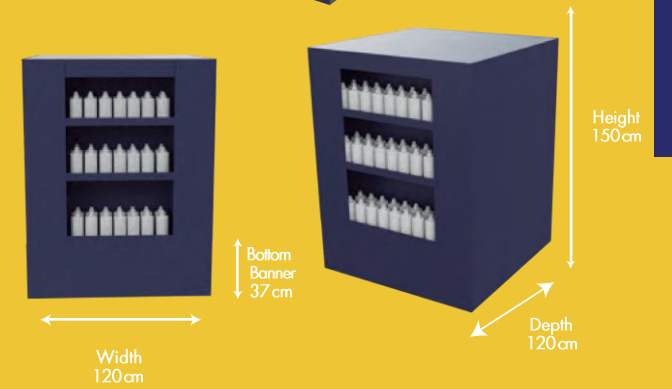

# Pallet Display Dump Bin

SD\_011

- Manufactured in corrugated cardboard
- Designed for quick and easy set-up at retail
- Reinforced design supports heavy loads
- Large space for branding
- Unfold it to assemble and place at retail



Video

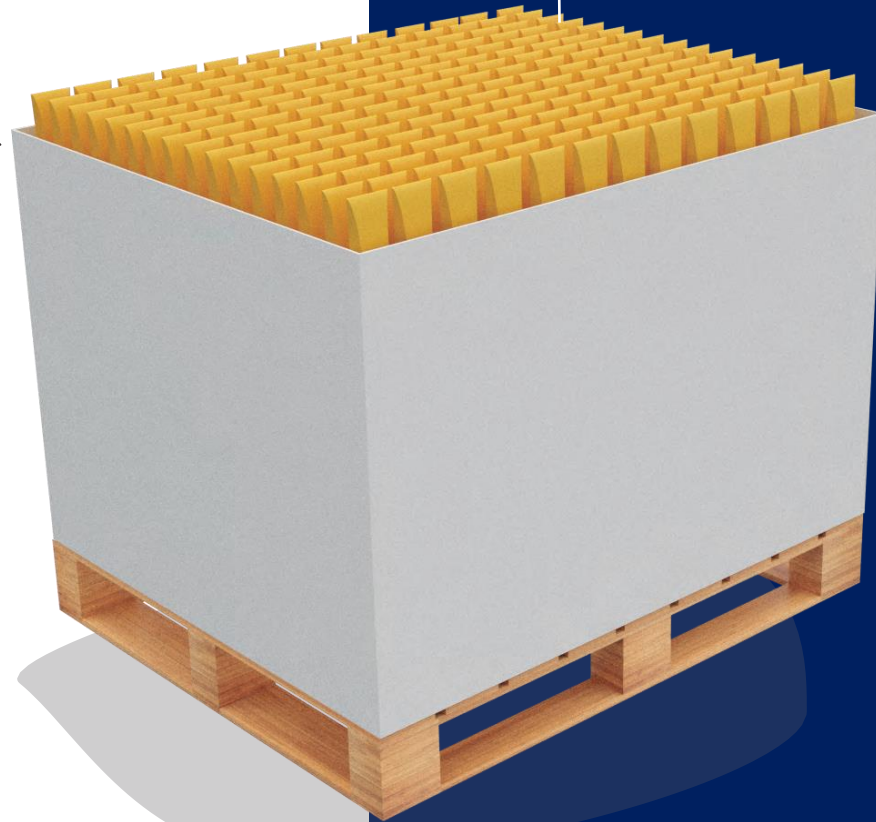
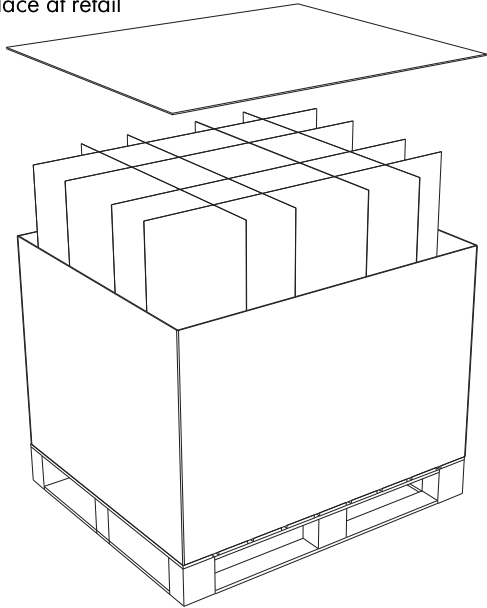

Load per level 50 Kg.

Space for product  
119 x 99 cm

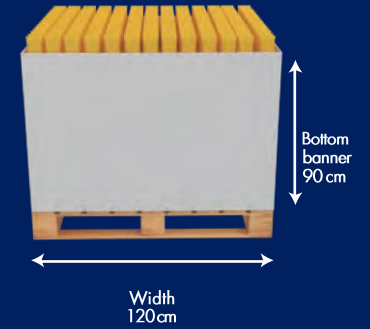

Width  
120 cm

Bottom  
banner  
90 cm

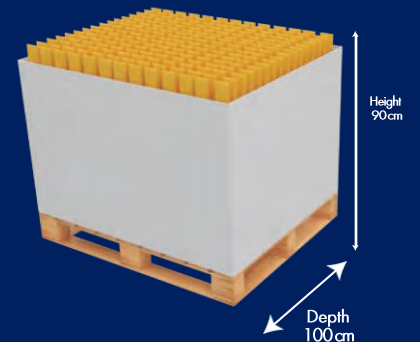

Height  
90 cm

Depth  
100 cm

# Pallet Display

SD\_017

- Manufactured in corrugated cardboard
- Designed for quick and easy setup at retail
- Unfold it to assemble at retail

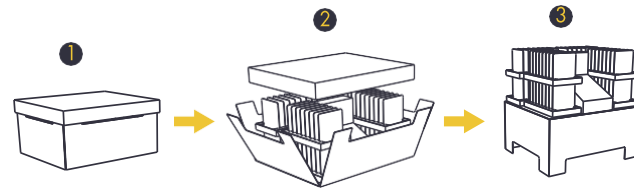

Space for Product  
59 x 35 cm

Space for Cards (64 pcs)  
28 x 33 cm

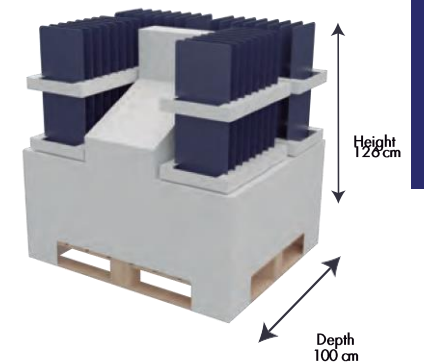
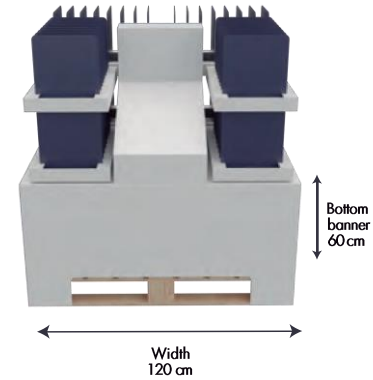
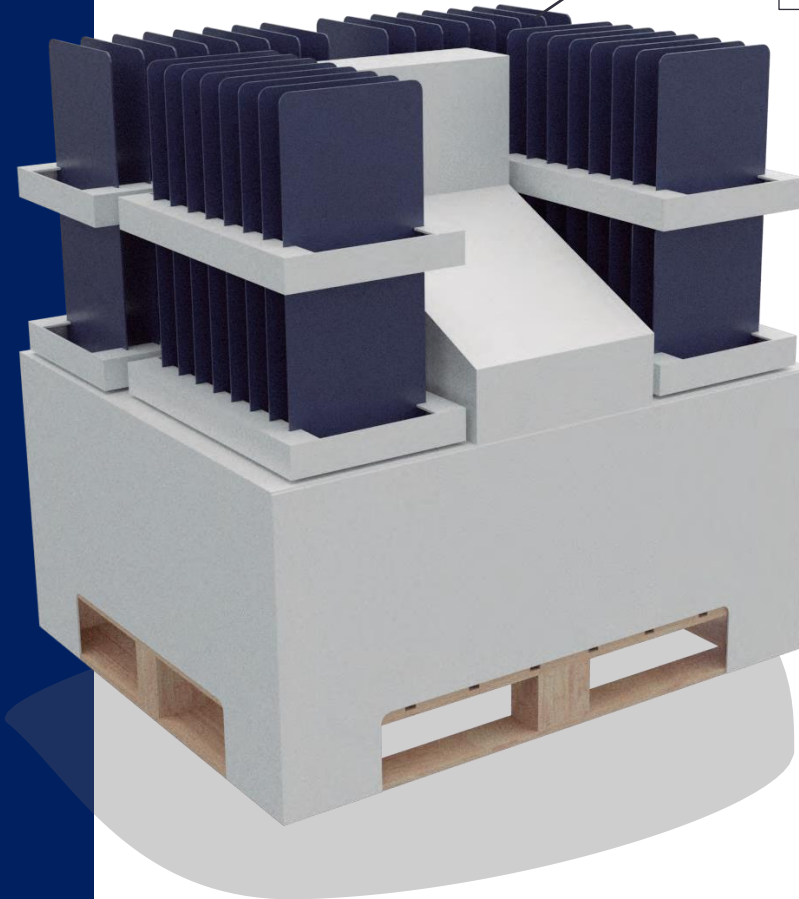
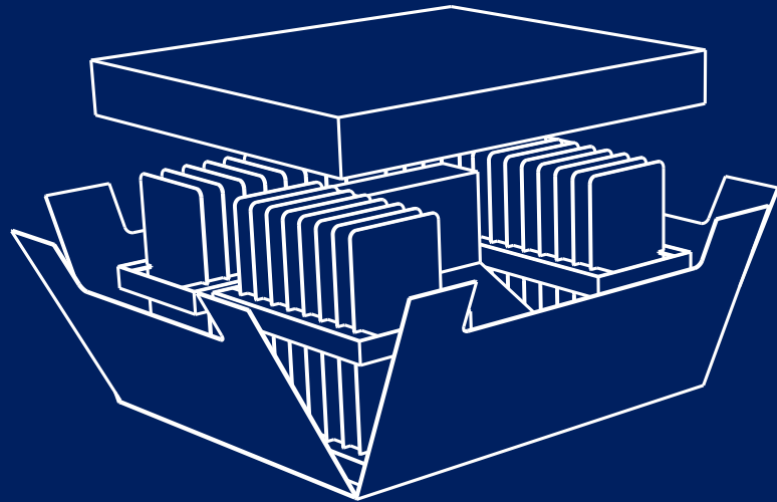

Perfect size to fit in a small car

# False Pallet

SD\_018

- Manufactured in corrugated cardboard
- Designed for quick and easy setup at retail
- Large space for branding
- Unfold it to assemble at retail

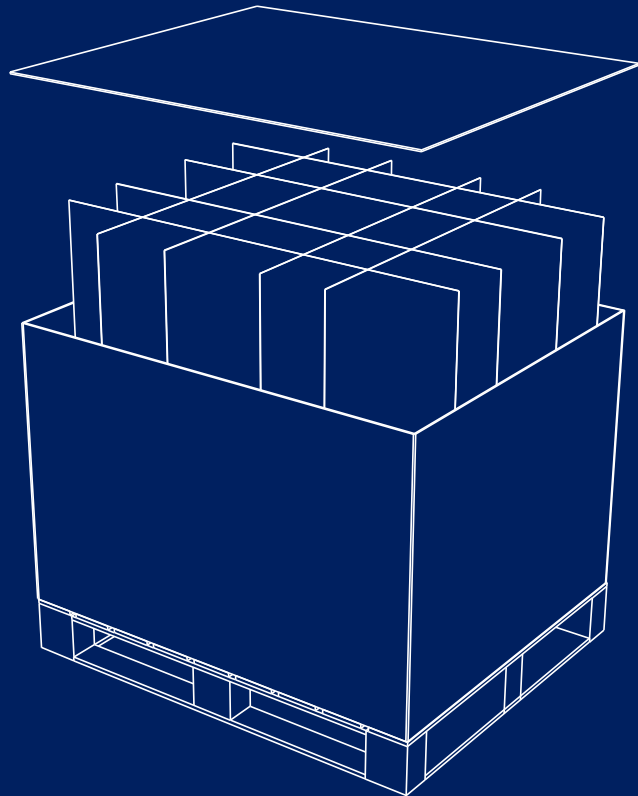

Perfect size to fit in a small car

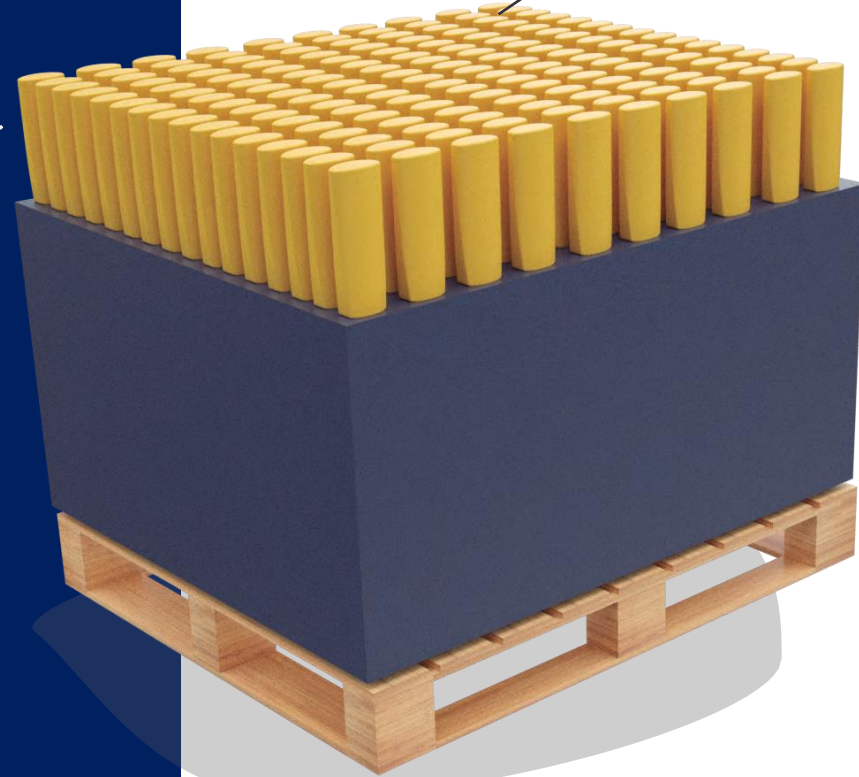

Load per level 50 Kg.

Space for product  
119 x 99 cm

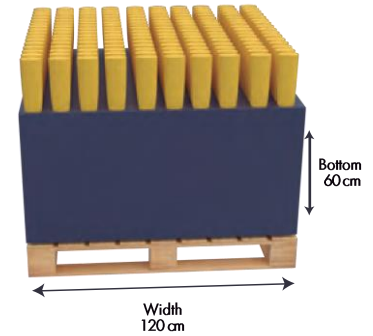

Width  
120 cm

Bottom  
60 cm

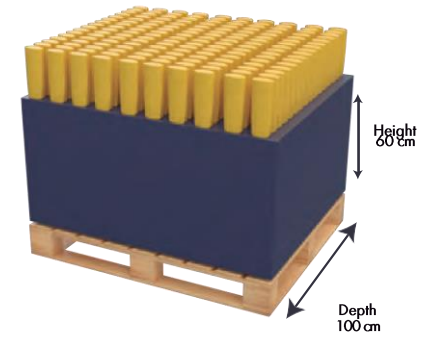

Height  
60 cm

Depth  
100 cm

# Maxi - Tray

SD\_019

- Manufactured in corrugated cardboard
- Designed for quick and easy set-up at retail
- Easy to stack
- Unfold it to assemble and place at retail

Assemble in  
**1**  
Minutes



Video

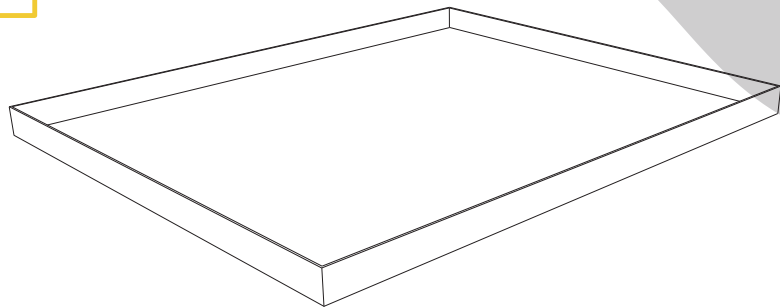

Space for product  
119x99 cm



Perfect size to fit in a small car

Height  
6 cm

Width  
120 cm

Depth  
100 cm

# Banner Display With base

SD\_014

- Manufactured SBS board and coroplast
- Semi-automatic assembly
- Ideal for branding
- Unfold it to assemble and place at retail

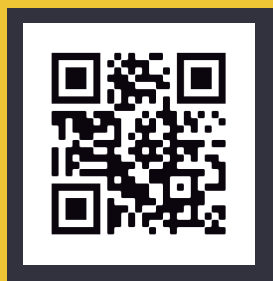

Video

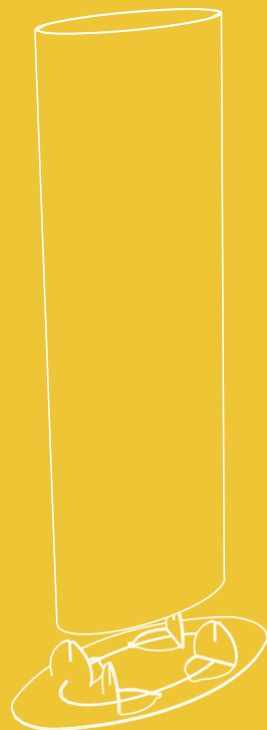

Perfect size to fit in a small car

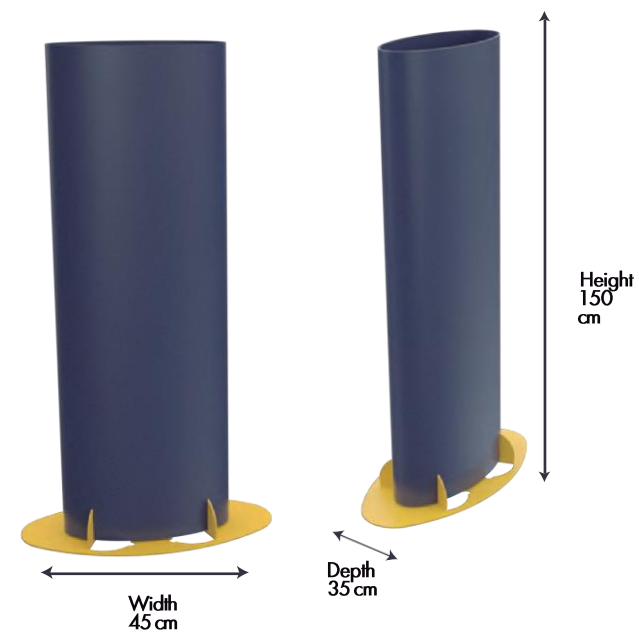

# Standee

SD\_015

- Manufactured in corrugated cardboard
- Ideal for branding
- Customizable shape, 40cm pop-out added
- Unfold it to assemble



Video

Assemble in  
**30**  
Seconds



Perfect size to fit in a small car

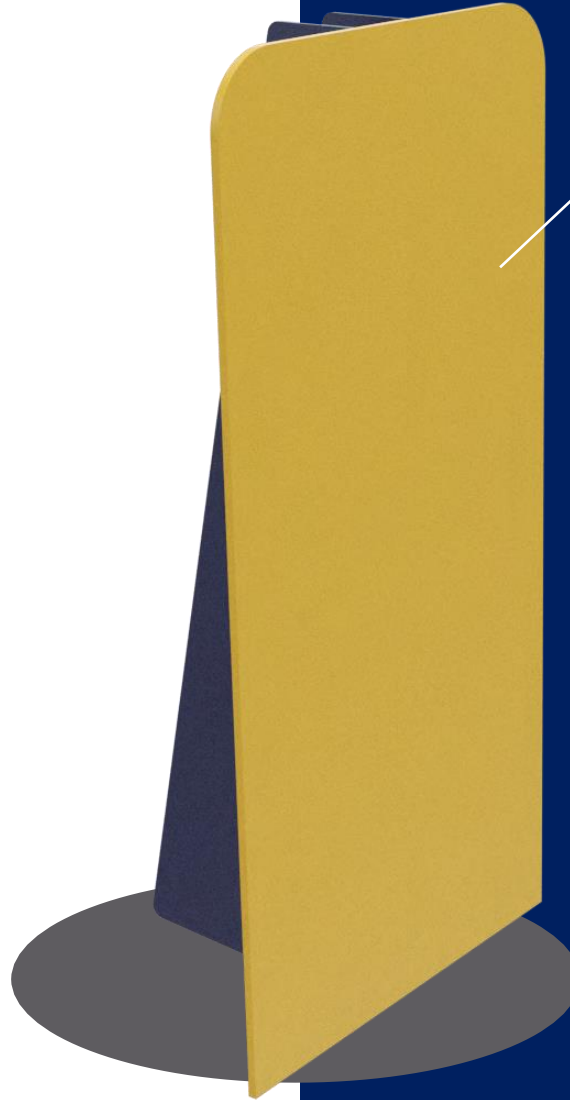
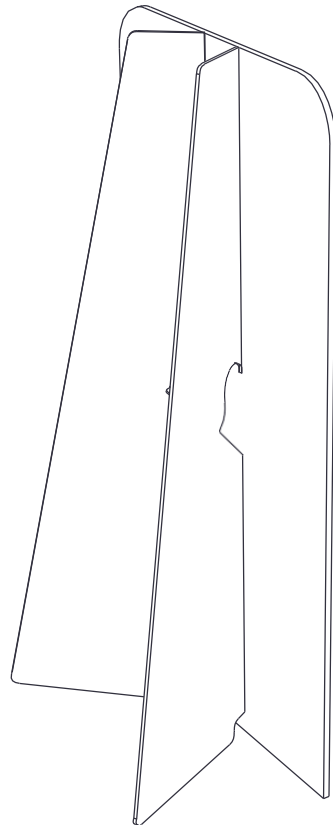

Customizable shape



Width  
45 cm



Height  
140 cm

Depth  
40 cm



A modern, multi-level building with a minimalist design. The building features a mix of light-colored concrete and dark, vertical-slat panels. A prominent feature is a rooftop garden with various green plants. The ground floor has a large glass entrance area. The sky is clear and blue.

# GPA GLOBAL CLIENT WORKS

gpa GLOBAL

BEYOND PACKAGING UNBOXING POTENTIAL

Display & POS material



POP Display - Paper



POP Display - Paper



## POP Display - Paper



POP Display – Permanent



POP Display – Permanent



VANS GINGER BREAD DISPLAY

## Pallet Display



Interactive display unit on the pallet adds point of sale to the product





## Pallet Display



BEYOND PACKAGING UNBOXING POTENTIAL

# Pallet Display



# Counter Display



## Dump Bins & End Cap Display

